

Varenummer: 204260M16125A1U

Beskrivelse: E+G Justerfod
GN 42-60-M16-125-A1-U

Note: U Uden møtrik, sekskant i toppen, spændeflade i bunden

Mål

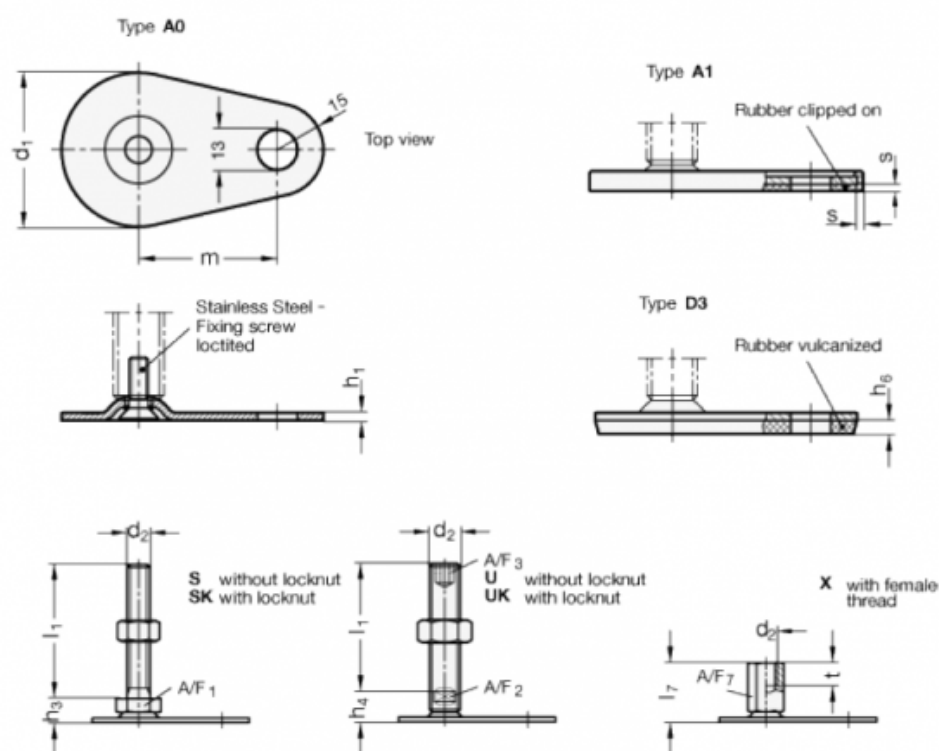

A/F2 = 12	m = 50
A/F3 = 8	s = 2
d1 = 60	
d2 = M16	
h1 = 2.5	
h4 = 17	
h6 =	
l1 = 125	